

MANUAL DE MONTAGEM  
Assembly instructions / Instrucciones de armado

ESTANTE CARACOL/BANDEIRA - 10 NICHOS

Bookcase Caracol - 10 nichos  
Estantería Caracol - 10 nichos

Código 2480/2552 | Revisão 02

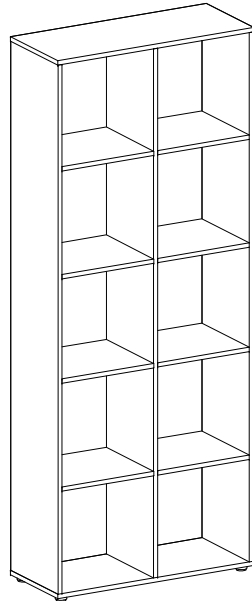

PESO MÁXIMO SUPORTADO PELAS PEÇAS, SENDO ESTE DISTRIBUÍDO UNIFORMEMENTE.

Maximum weight supported by parts, being this evenly distributed.  
Peso máximo soportado por las partes, siendo esta distribuido uniformemente.

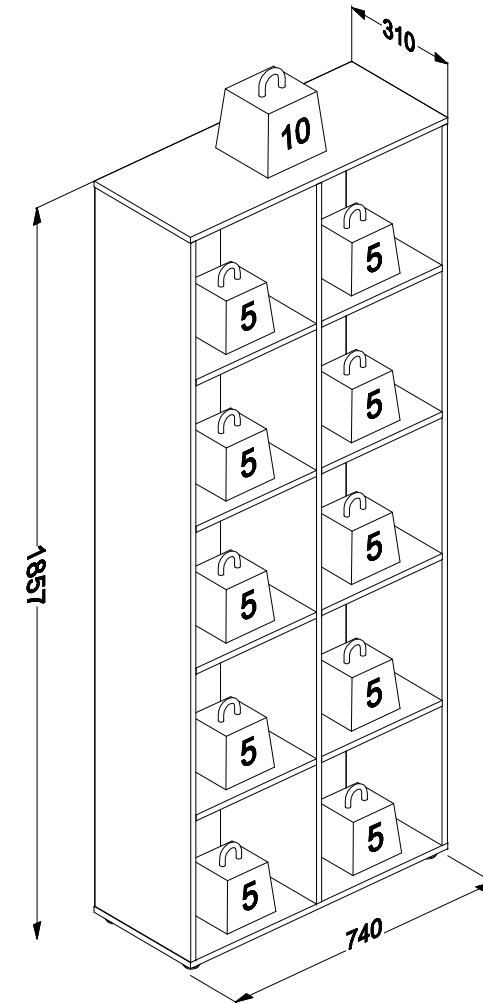

Você vai precisar de/ You will need / Usted necesitará

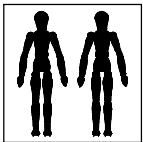

2 Pessoas  
2 People  
2 Personas

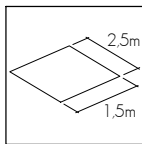

Espaço recomendado para montagem  
Recommended space for assemble  
Espacio recomendado para el armado

Ferramentas não inclusas  
Tools not included / Herramientas no incluidas

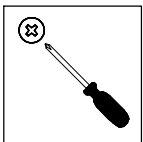

Chave Phillips  
Screwdriver Phillips  
Destornillador cruz

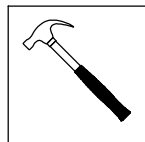

Martelo  
Hammer  
Martillo

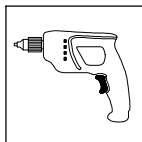

Furadeira  
Drill machine  
Taladro

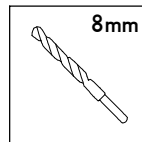

Broca  
Drill bit  
Taladro







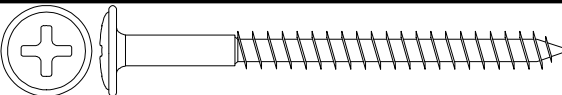
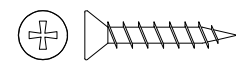
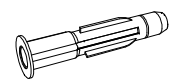
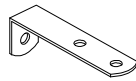

\* PESO EM KG/ Weight in Kg/ Peso en Kg  
DIMENSÕES EM MM/ Dimensions in mm/ Dimensiones en mm

**IDENTIFICAÇÃO DOS ACESSÓRIOS / IDENTIFICATION OF ACCESSORIES/ IDENTIFICACIÓN DE ACCESORIOS**

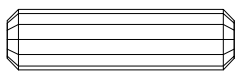
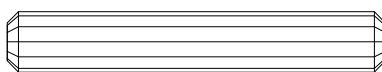
**NOTAS:** A separação dos acessórios antes de iniciar a montagem facilitará a mesma. Os parafusos e cavilhas estão na escala real. Em caso de dúvida na identificação, coloque o acessório sobre a imagem.

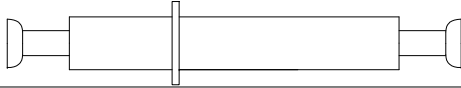
**NOTES:** The separation of the accessories before you start the assembly will facilitate the same. The screws and dowels are in real scale. In case of doubts about the identification, place the accessory on the image.

**NOTAS:** La separación de los accesorios antes de comenzar el armado facilitará el mismo. Los tornillos y taquetes son en escala real. En caso de dudas sobre la identificación, coloque el accesorio en la imagen.

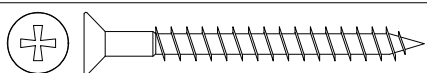
A		<b>Parafuso flangeado</b> Flanged head screw Tornillo de cabeza flangeada	5,0x60 mm	<b>01</b>
A8		<b>Parafuso chato</b> Flat head screw Tornillo de cabeza plana	3,5x20 mm	<b>06</b>
B3		<b>Bucha expansiva</b> Bushing Tapón	8x50 mm	<b>01</b>
B7		<b>Suporte de metal</b> Metalic bracket Soporte de metal	-	<b>01</b>
C1		<b>Garra de metal</b> Metal claw Garra metal	-	<b>10</b>
E		<b>Cavilha</b> Wooden Dowel Pin	8x30 mm	<b>28</b>
F		<b>Cavilha</b> Wooden Dowel Pin	8x50 mm	<b>08</b>
J		<b>Haste minifix simples</b> Simple minifix screw Tornillo minifix simple	-	<b>04</b>
K		<b>Haste minifix dupla</b> Double minifix screw Tornillo minifix doble	60 mm	<b>02</b>
L		<b>Tambor minifix</b> Drum lock Tambor minifix	12 mm	<b>08</b>
L4		<b>Sapata</b> Small plastic foot Pie plástico	38x17 mm	<b>06</b>
M		<b>Tapa furo adesivo</b> Bore patch adhesive Tapones adhesivo	-	<b>08</b>
N		<b>Prego</b> Nail Clavo	10 x10	<b>55</b>
O		<b>Parafuso chato</b> Flat head screw Tornillo de cabeza plana	4,5x45 mm	<b>12</b>

S

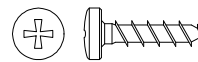

**Parafuso panela**  
Pan head screw  
Tornillo de pan

3,5x14 mm

**02**

**IDENTIFICAÇÃO DAS PEÇAS/ PARTS IDENTIFICATION/ IDENTIFICACIÓN DE LAS PIEZAS**

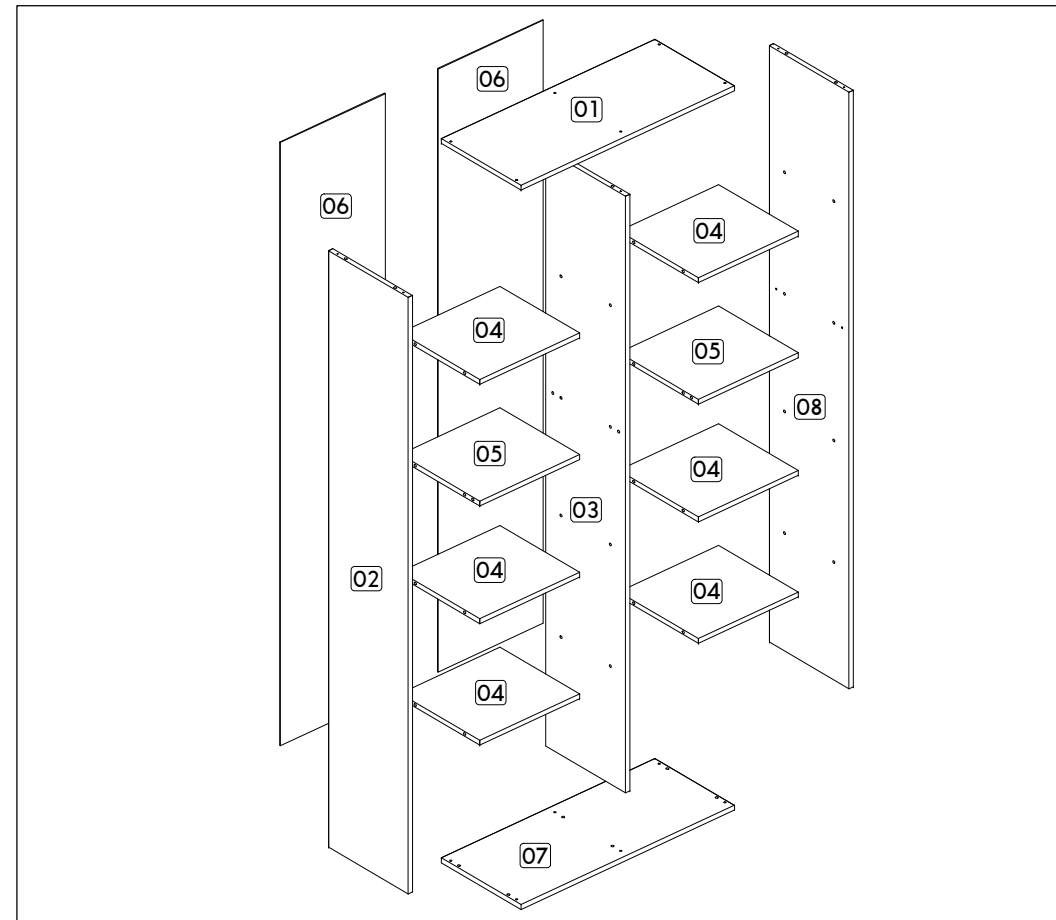

Nº	DESCRIÇÃO - DESCRIPTION - DESCRIPCIÓN	MEDIDAS-MEASURES - MEDIDAS (mm)	QTD.
01	<b>Base</b> - Base - Base	740 x 310 x 15	01
02	<b>Lateral esquerda</b> - Left side - Lateral izquierda	1810 x 310 x 15	01
03	<b>Divisória</b> - Partition - Divisoria	1810 x 310 x 15	01
04	<b>Prateleira</b> - Shelf - Repisa	346 x 310 x 15	06
05	<b>Prateleira fixa</b> - Fixed shelf - Repisa fija	346 x 310 x 15	02
06	<b>Costa</b> - Backboard - Fondo	1830 x 363 x 03	02
07	<b>Base inferior</b> - Bottom base - Base inferior	740 x 310 x 15	01
08	<b>Lateral direita</b> - Right side - Lateral derecha	1810 x 310 x 15	01

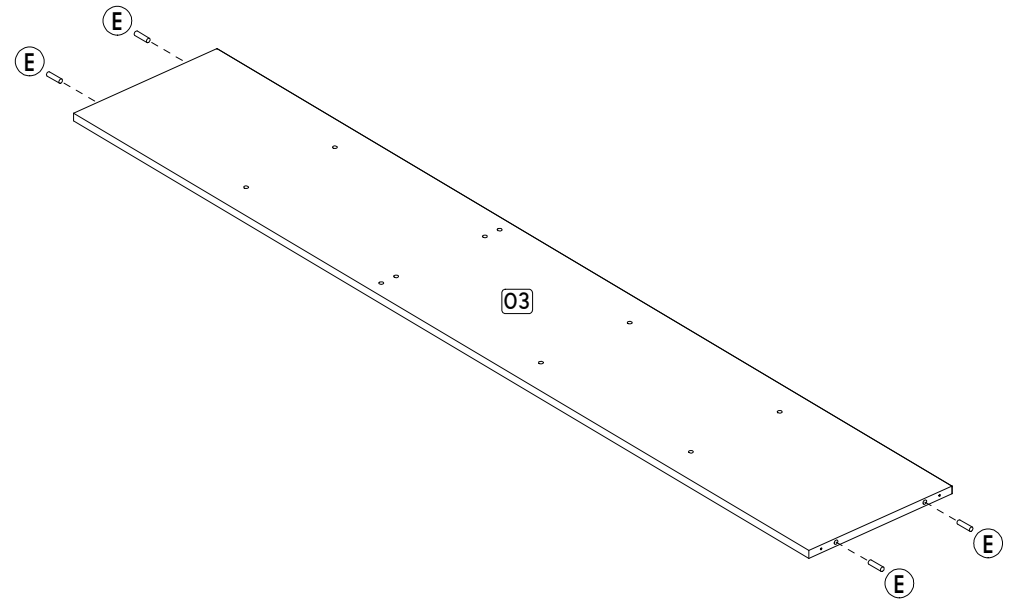
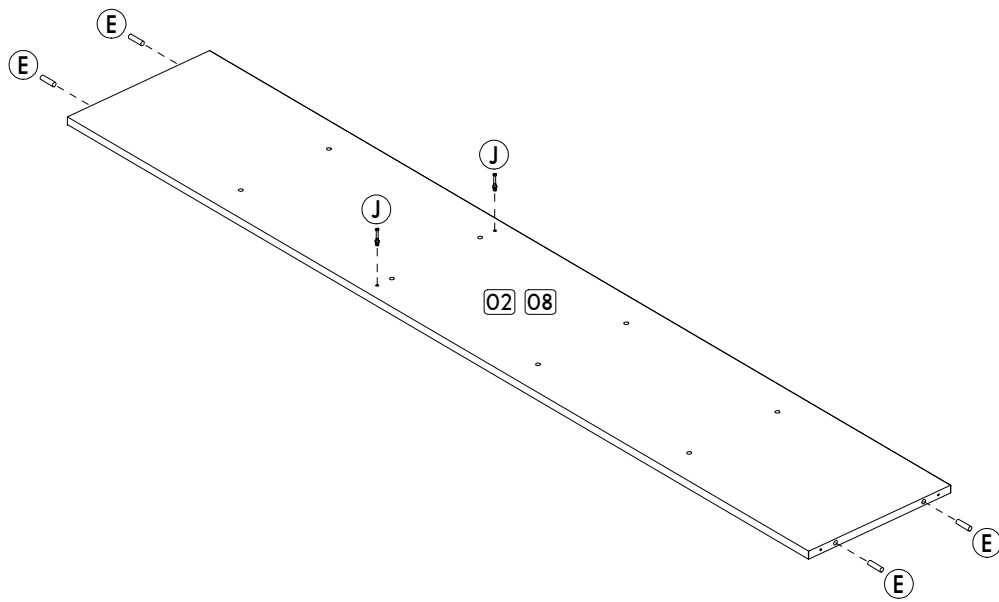

Passo/ Step/ Paso 01

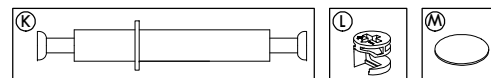
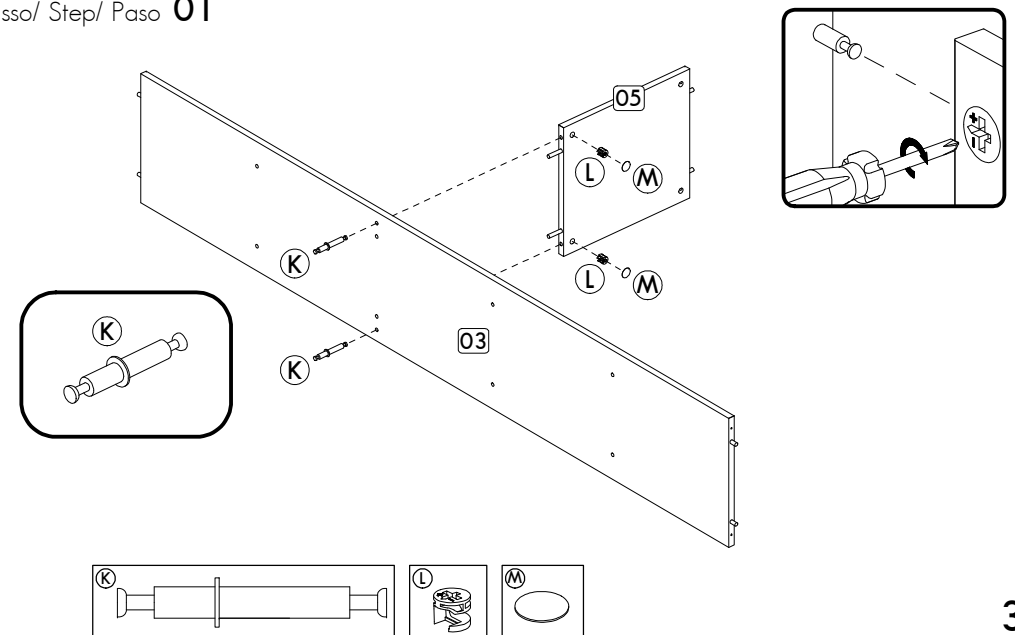
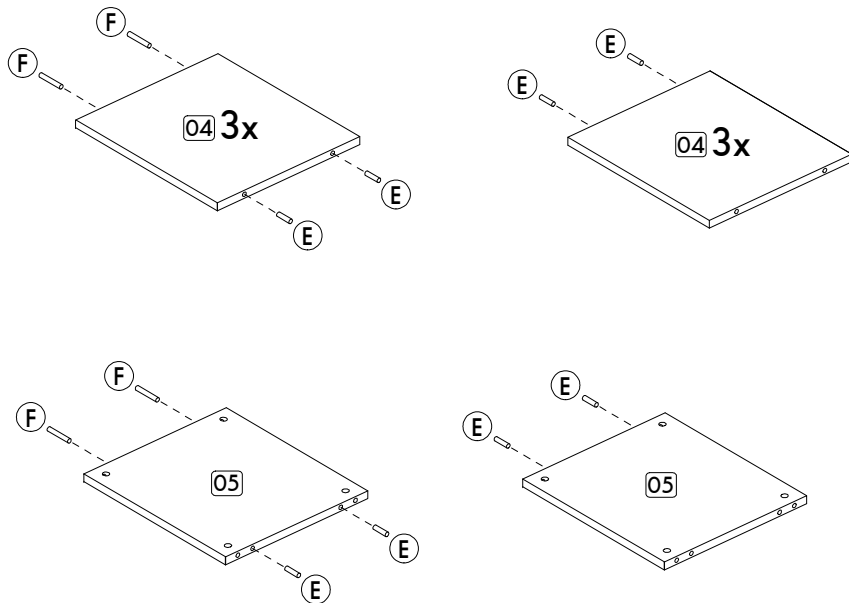

Passo/ Step/ Paso 02

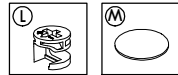
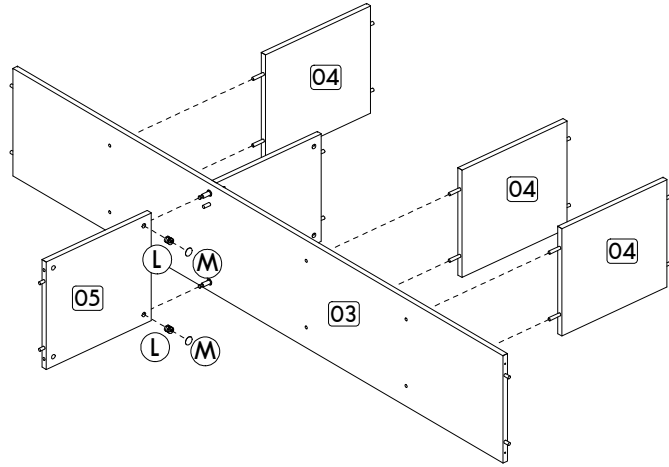

Passo/ Step/ Paso 04

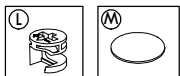
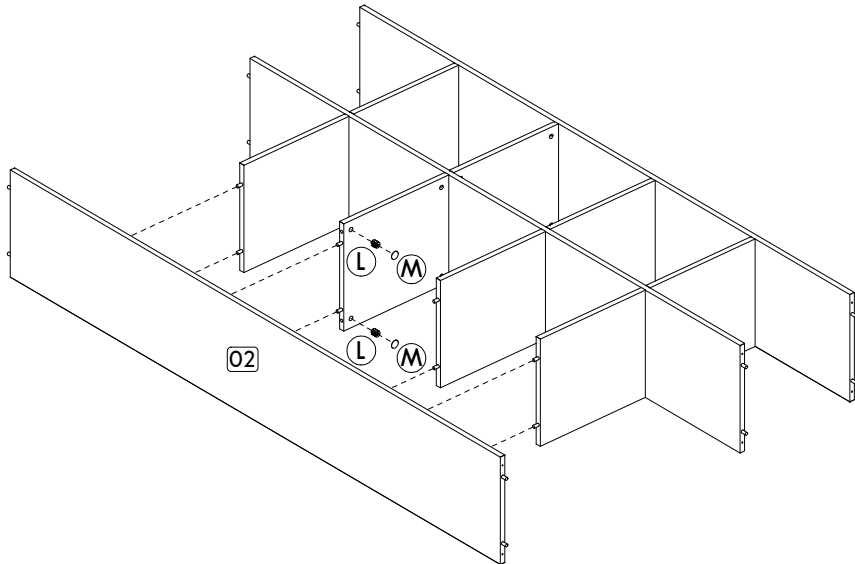

Passo/ Step/ Paso 03

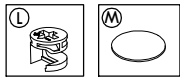
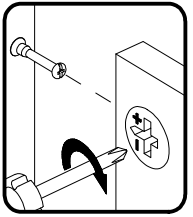
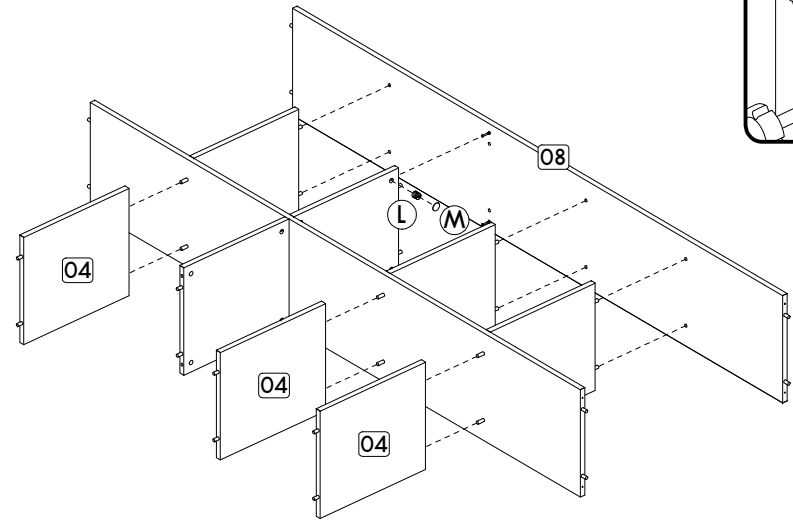

Passo/ Step/ Paso 05

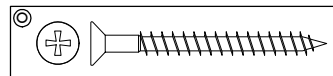
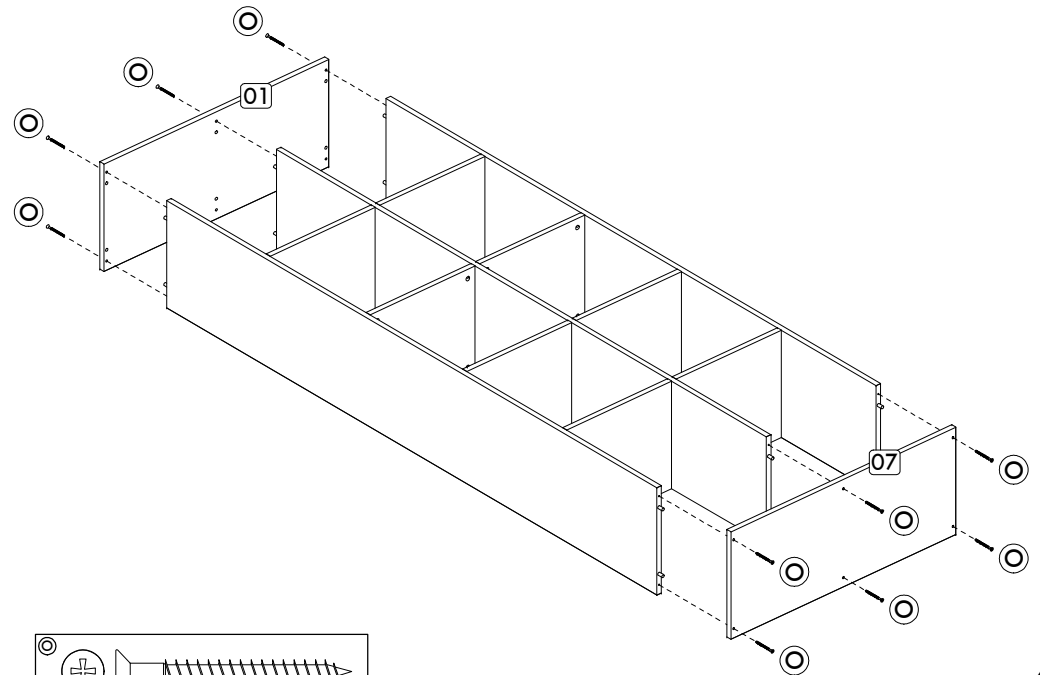

Passo/ Step/ Paso 06

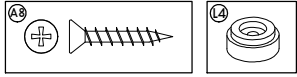
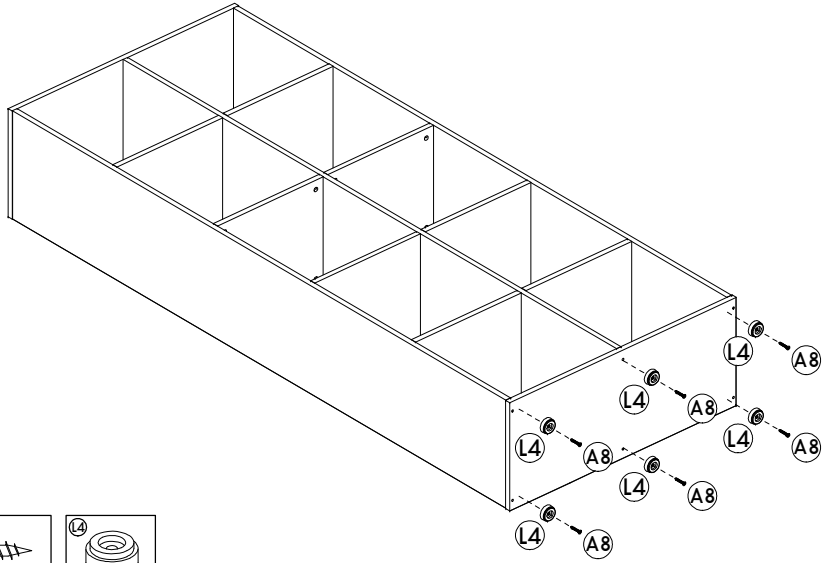

Passo/ Step/ Paso 07

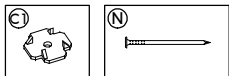
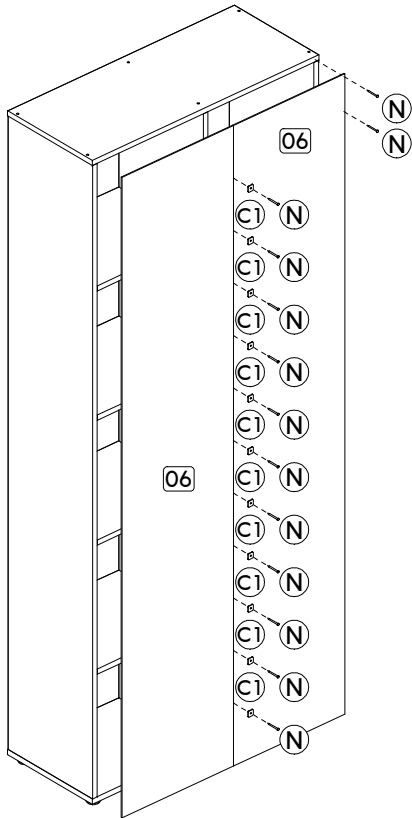

Passo/ Step/ Paso 08

