

MANUAL DE MONTAGEM

ASSEMBLY INSTRUCTIONS / INSTRUCCIONES DE ARMADO

ARMÁRIO UNA
UNA cabinet
Armario UNA

Código **180407** | Revisão 00

Português
English
Español

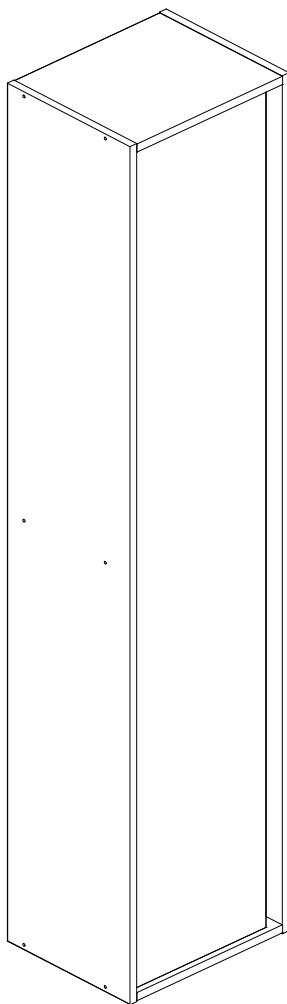

VOCÊ VAI PRECISAR DE / YOU WILL NEED / USTED NECESITARÁ

Ferramentas não fornecidas / Tools not supplied / Herramientas no incluidas

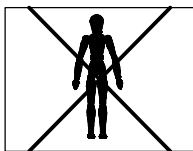

1 Pessoa
1 Person
1 Persona

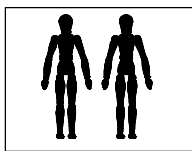

2 Pessoas
2 People
2 Personas

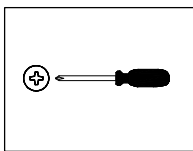

Chave Phillips
Screwdriver Phillips
Destornillador cruz

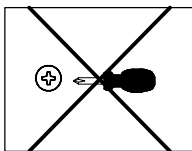

Chave Phillips Menor
Small screwdriver Phillips
Destornillador cruz menor

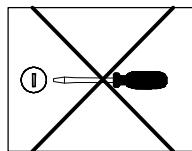

Chave fenda
Screwdriver slotted
Destornillador plano

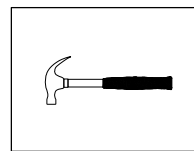

Martelo
Hammer
Martillo

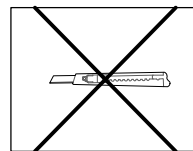

Estilete
Stylet
Estilete

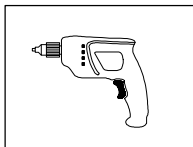

Furadeira
Drill machine
Taladro

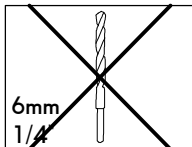

Broca
Drill bit
Taladro

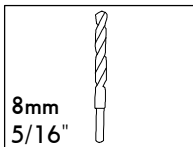

Broca
Drill bit
Taladro

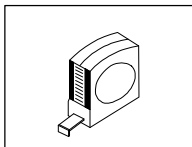

Trena
Measuring tape
Cinta de medición

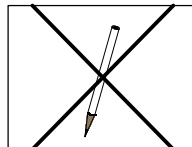

Lápis
Pencil
Lápiz

NOTAS: A separação dos acessórios antes de iniciar a montagem facilitará a mesma. Em caso de dúvida no tamanho dos parafusos e cavilhas, utilize a régua ao final da página 2.

NOTES: The separation of the accessories before you start the assembly will facilitate the same. In case of doubt on the size of the screws and bolts, use the ruler to bottom of page 2.

NOTAS: La separación de los accesorios antes de comenzar el armado facilitará el mismo. En caso de duda sobre el tamaño de los tornillos y taquetes, utilice la regla al pie de página 2.

IDENTIFICAÇÃO DOS ACESSÓRIOS/ IDENTIFICATION OF ACCESSORIES/ IDENTIFICACIÓN DE ACCESORIOS

A		Parafuso flangeado / Flanged head screw / Tornillo de cabeza flangeada	5,0x60 mm	2
B3		Bucha expansiva / Bushing / Tapón	8x50 mm	2
D5		Calço dobradiça / Hinge shim / Bisagra de calce	-	3
D6		Dobradiça super alta / Metal hinge super high / Bisagra alta	26 mm	3
D14		Moldura / Frame / Marco	-	1
E		Cavilha / Wooden dowel / Taquete	8x30 mm	12
E3		Suporte de prateleira / Shelf bracket / Suporte de repisa	8x7 mm	8
G		Parafuso estrutural / Structural screw / Tornillo estructural	5,0x50 mm	12
H		Chave allen / Allen key / Liave allen	3 mm	1
I		Tampa parafuso estrutural / Structural screw cover / Tapa tornillo estructural	-	12
N		Prego / Nail / Clavo	10 x10	38
N5		Suporte "L" / Support "L" / Soporte "L"	-	2
N6		Capa / Cover / Cubierta	-	2
R5		Parafuso chato / Flat head screw / Tornillo de cabeza plana	4,5x30 mm	6
S		Parafuso panela / Pan head screw / Tornillo de pan	3,5x14 mm	16



IDENTIFICAÇÃO DAS PEÇAS / PARTS IDENTIFICATION/ IDENTIFICACIÓN DE LAS PIEZAS

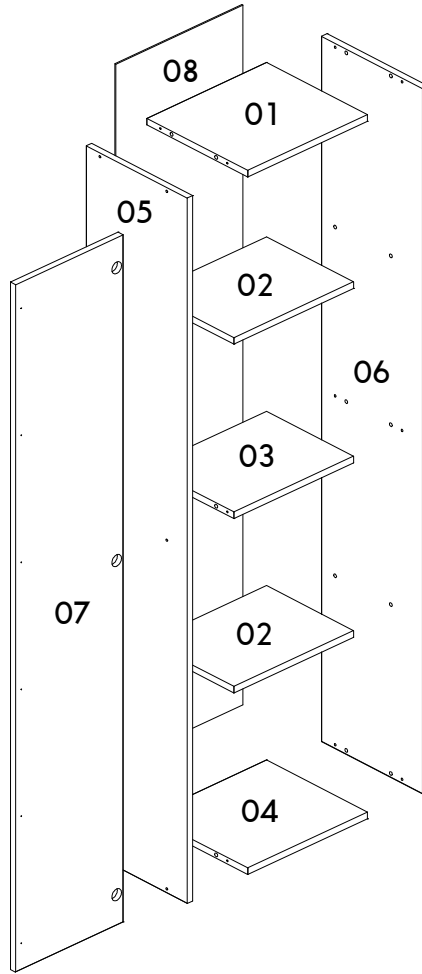

Número / Number / Número	Medidas / Measures / Medidas		Qtd. / Qty. / Qtd.
	cm	inches	
01	32,6 x 29 x 1,5	12" 7/8 x 11" 3/8 x 5/8	1
02	32,6 x 25 x 1,5	12" 7/8 x 9" 7/8 x 5/8	2
03	32,6 x 25 x 1,5	12" 7/8 x 9" 7/8 x 5/8	1
04	32,6 x 29 x 1,5	12" 7/8 x 11" 3/8 x 5/8	1
05	160 x 29 x 1,5	63" x 11" 3/8 x 5/8	1
06	160 x 29 x 1,5	63" x 11" 3/8 x 5/8	1
07	29,3 x 155,9 x 1,5	11" 1/2 x 61" 3/8 x 5/8	1
08	158,7 x 34,6 x 0,3	62" 1/2 x 13" 5/8 x 1/8	1

01

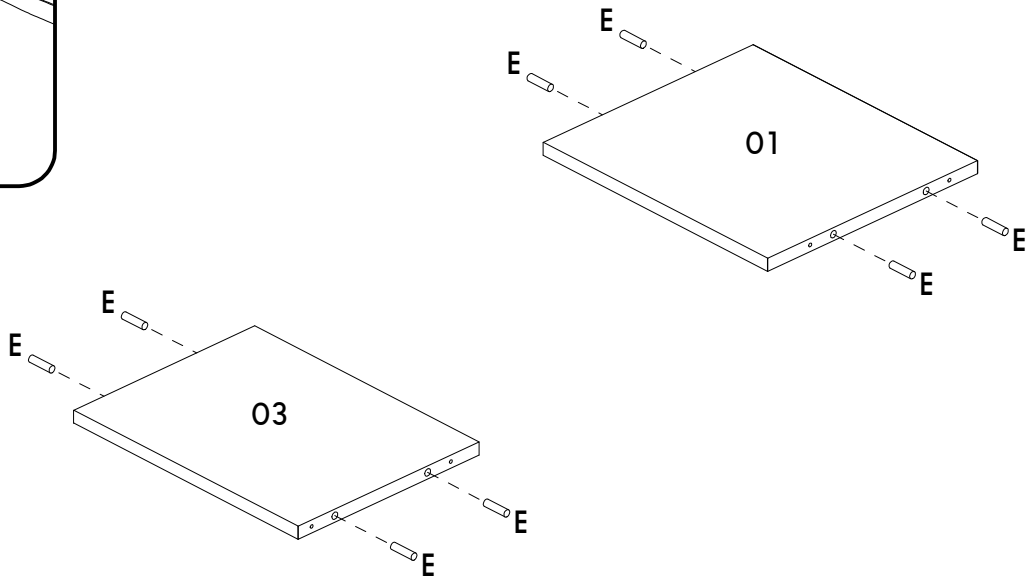
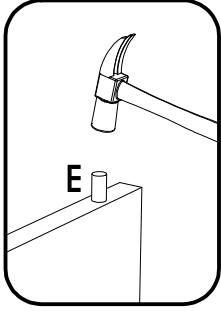

02

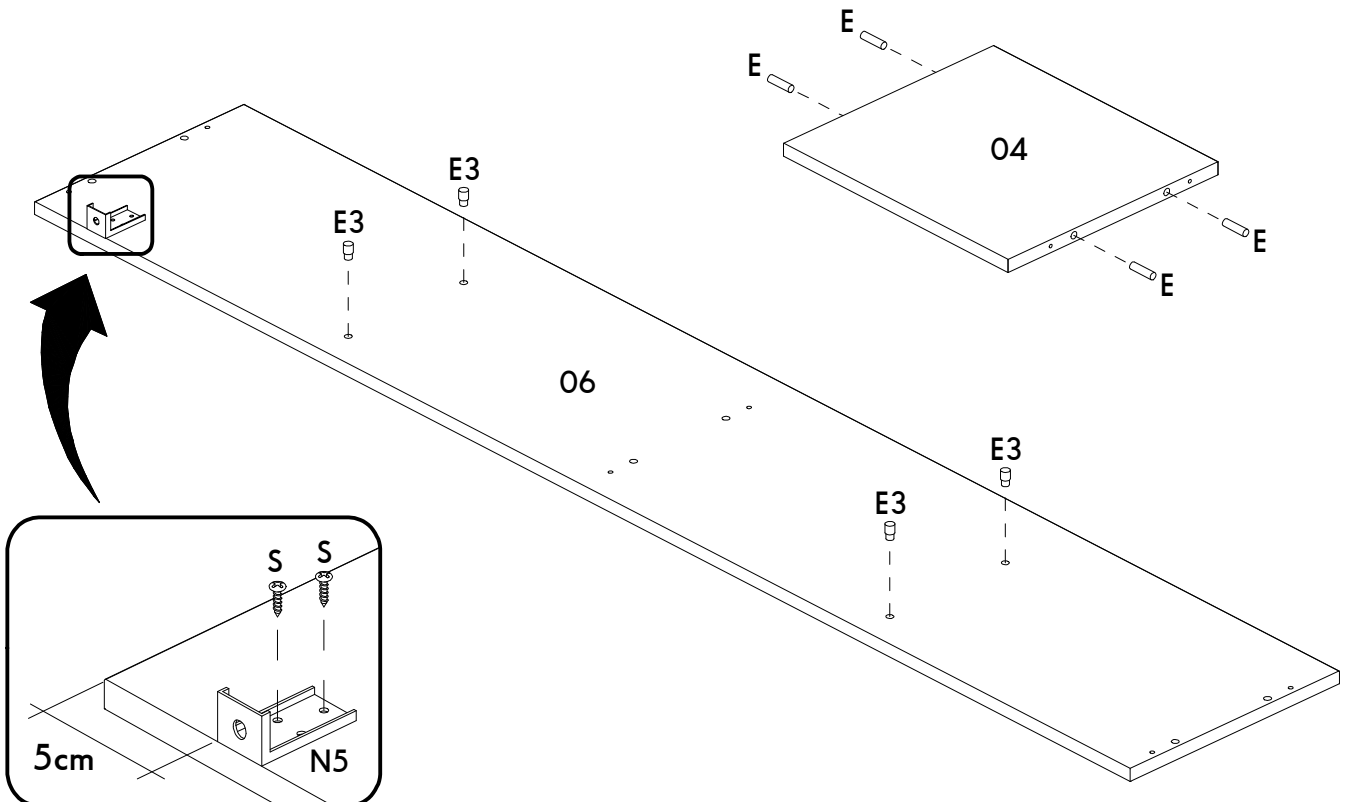

03

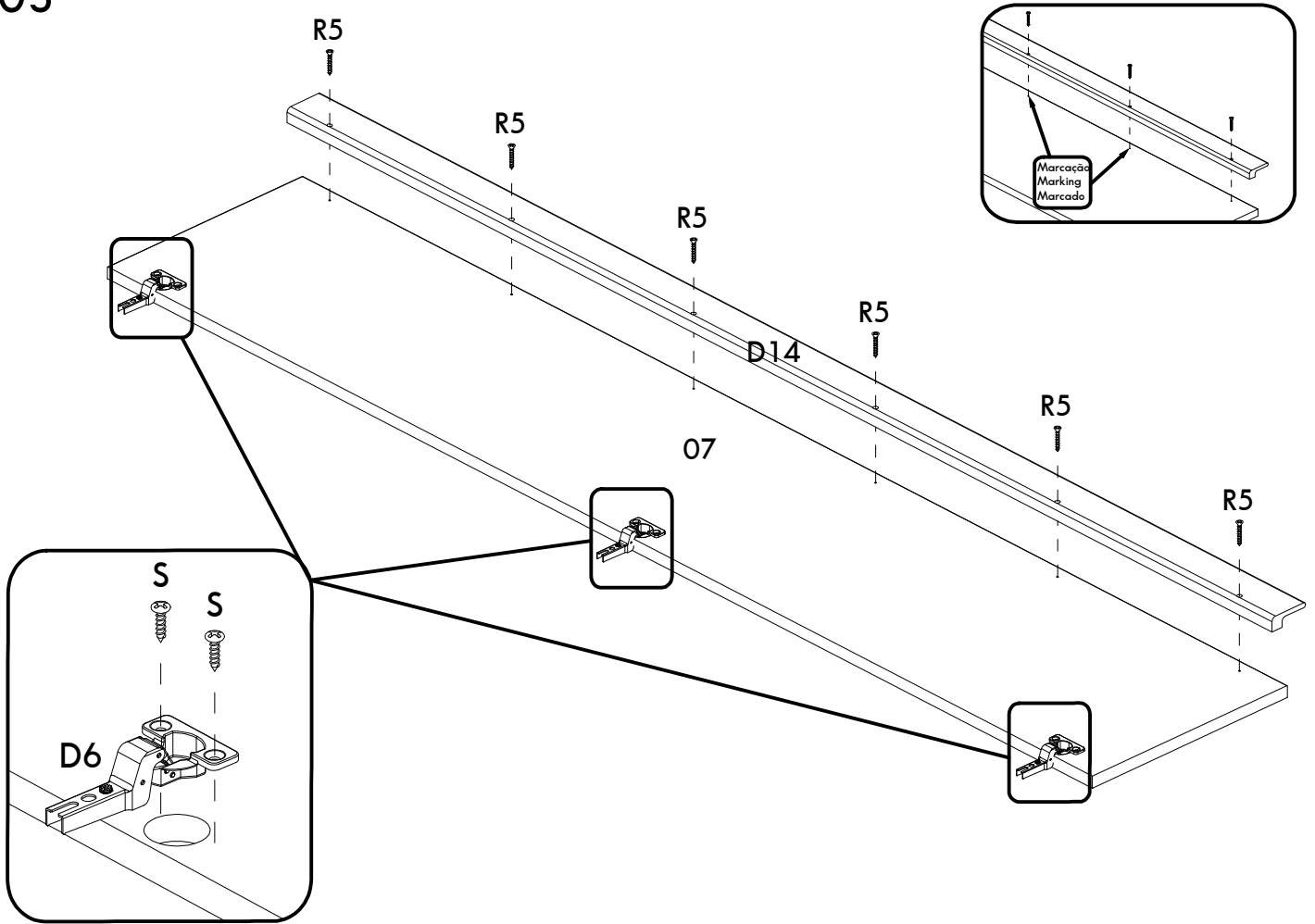

04

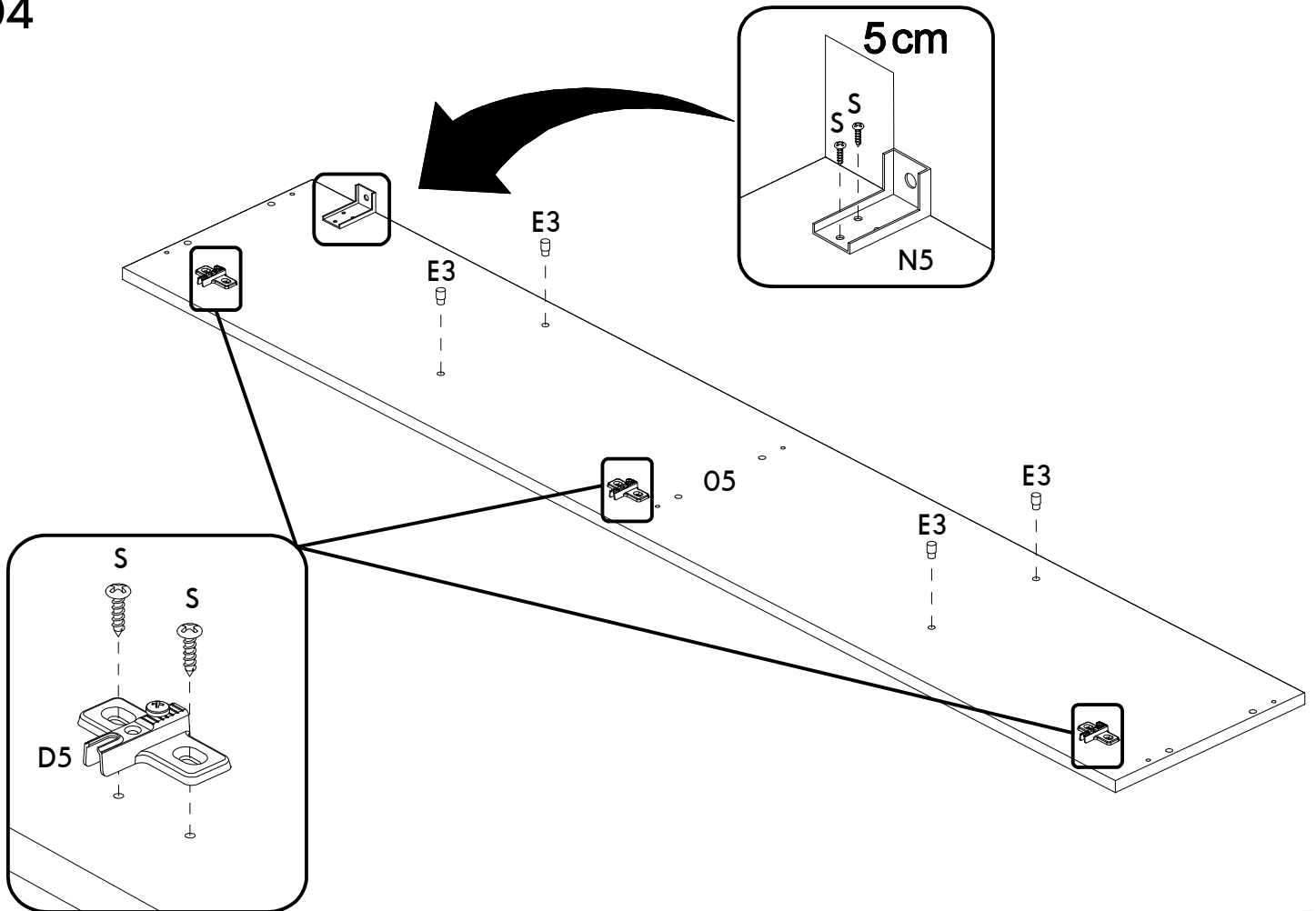

05

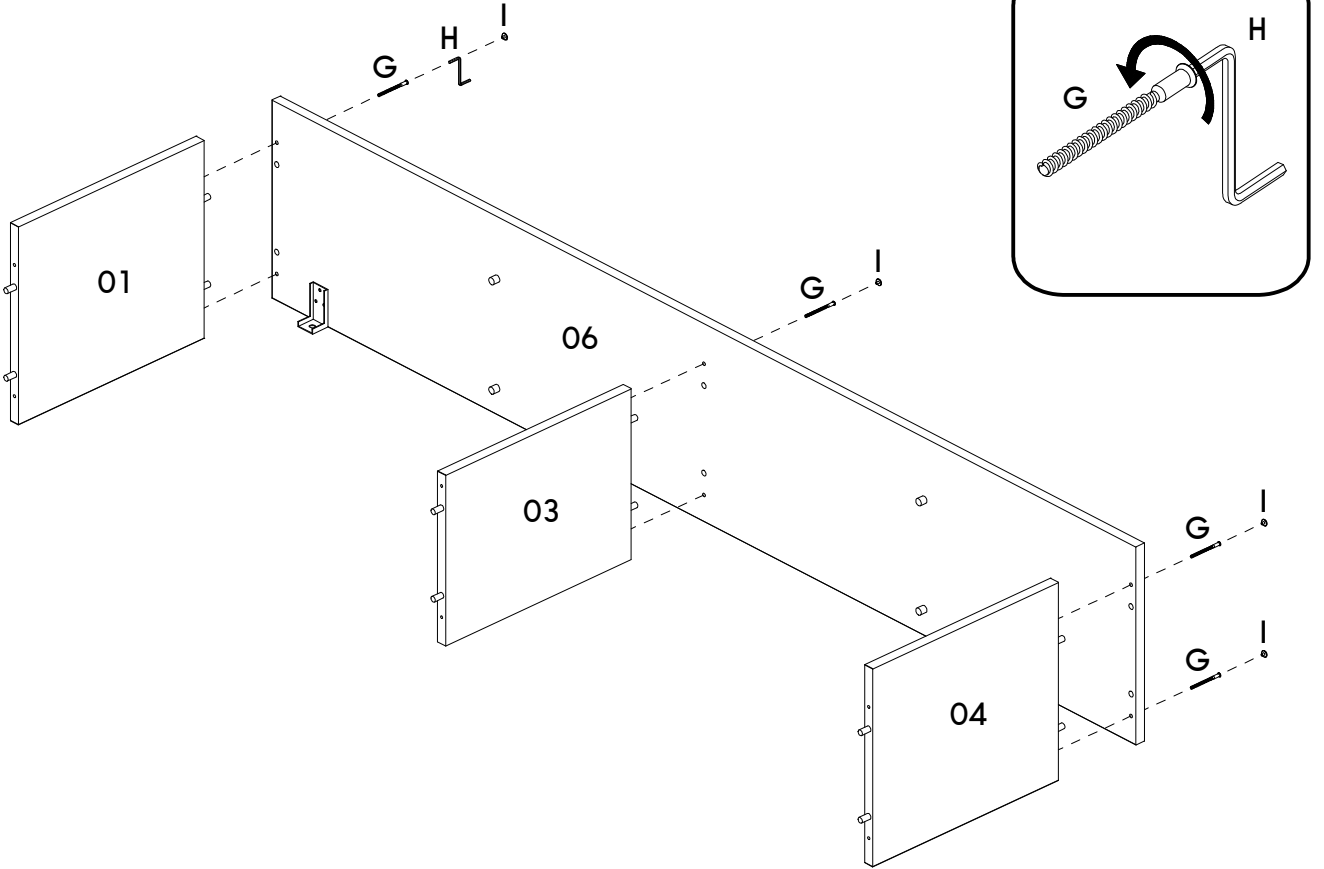

06

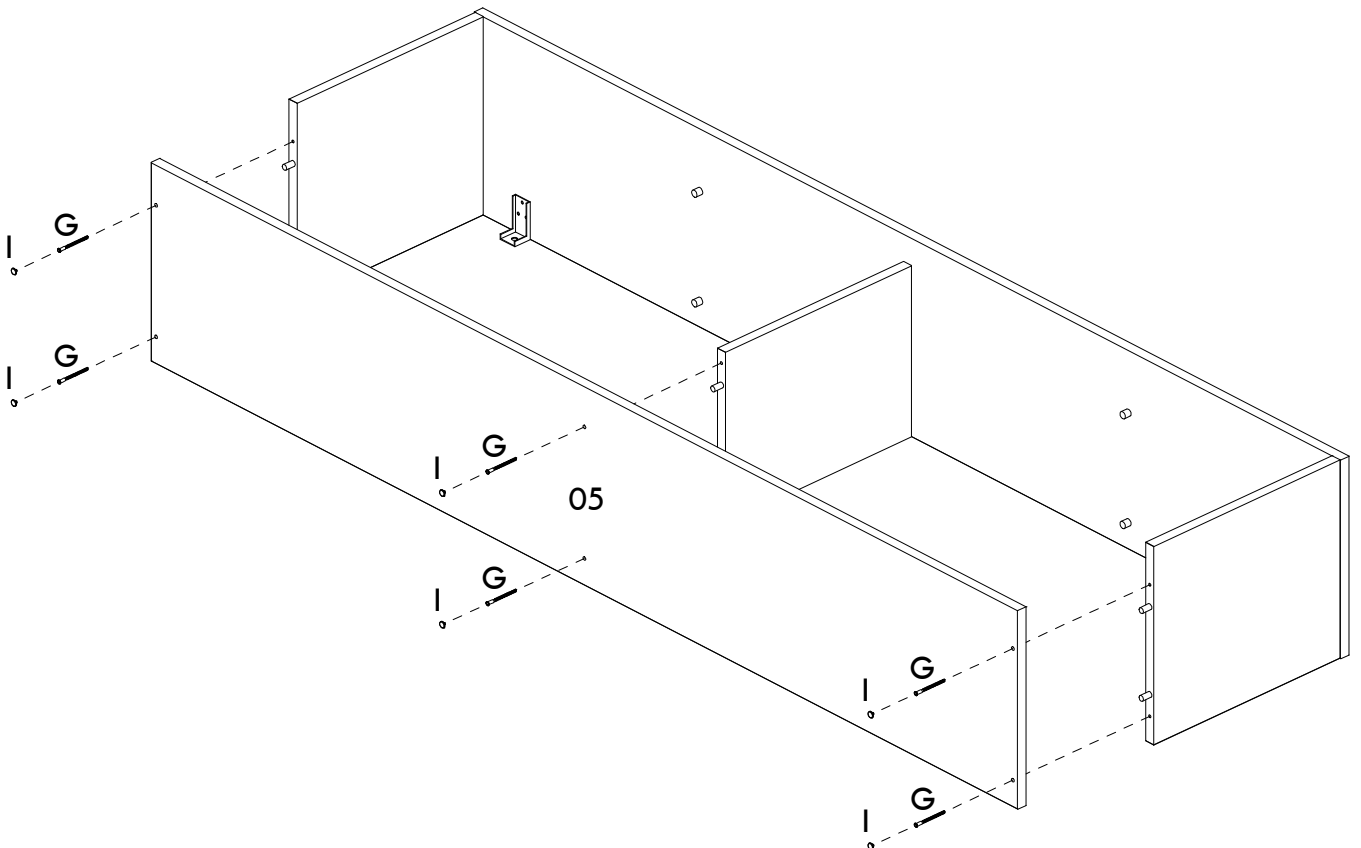

07

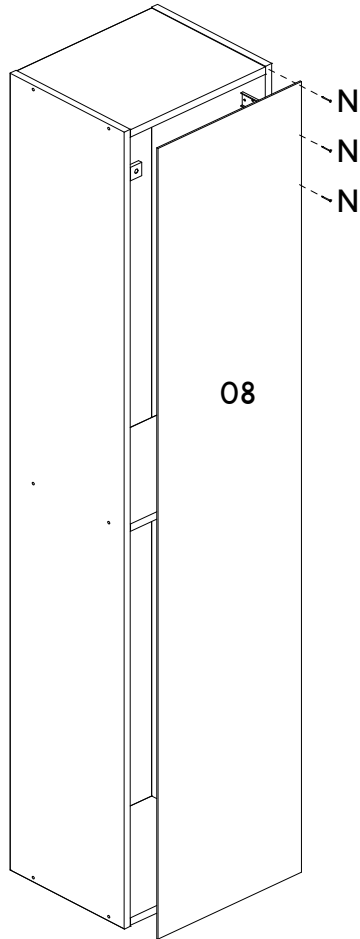

08

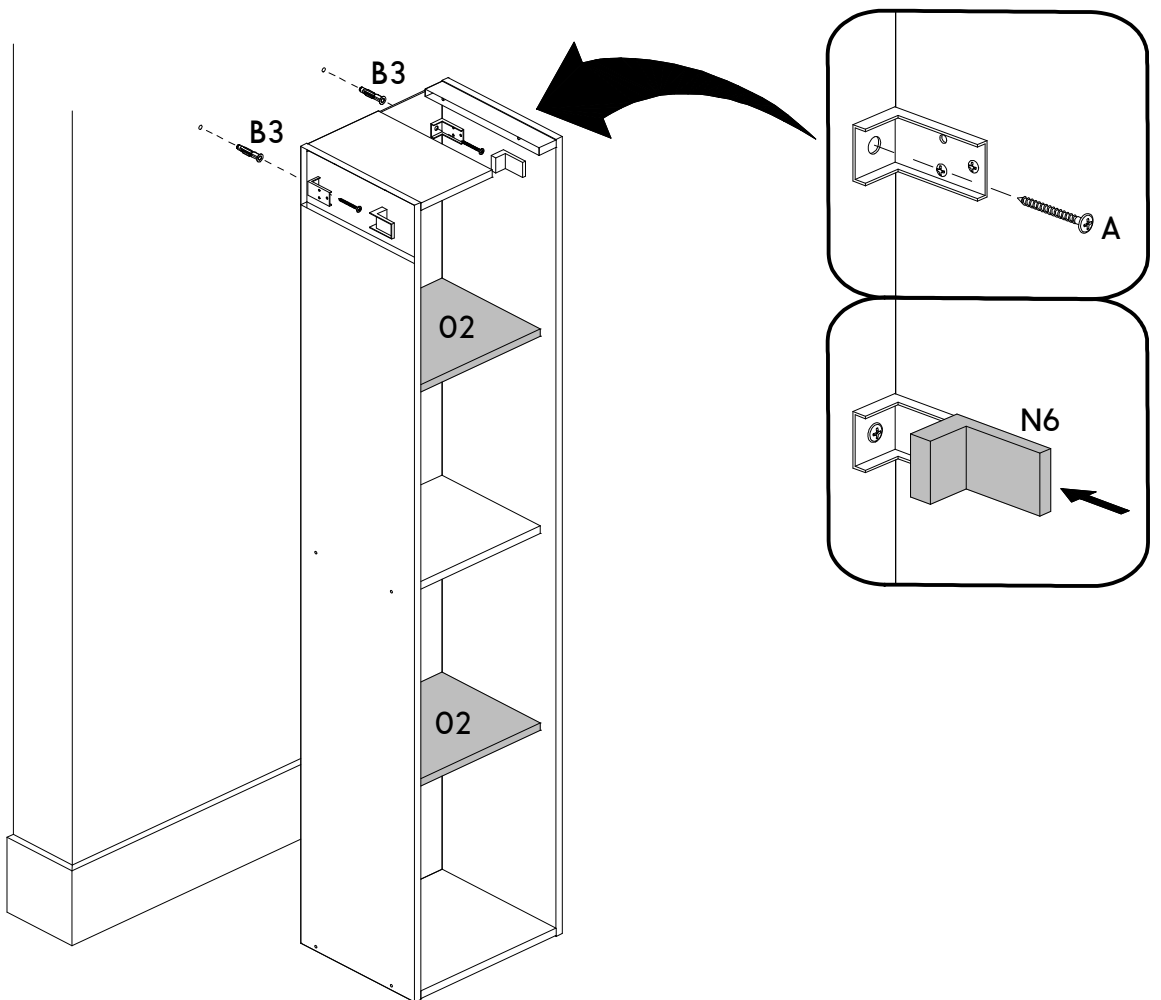

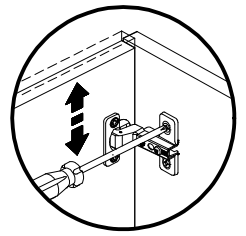
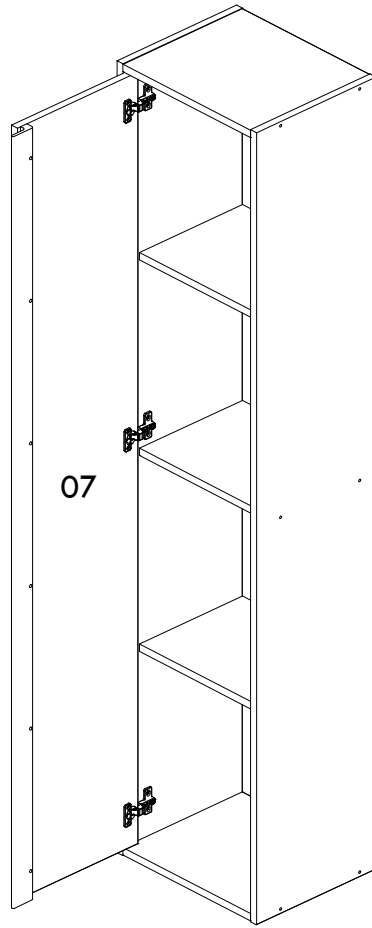

Regulagem Vertical
Ajuste Vertical
Vertical Adjustment

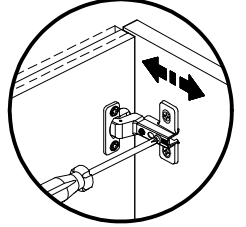

Regulagem Profundidade
Ajuste Profundidad
Depth Adjustment

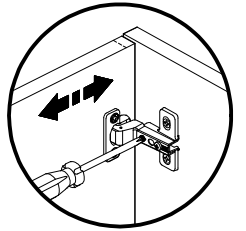

Regulagem Horizontal
Ajuste Horizontal
Horizontal Adjustment

PESO MÁXIMO RECOMENDADO SENDO ESTE DISTRIBUÍDO UNIFORMEMENTE
MAXIMUM RECOMMENDED WEIGHT BEING THIS EVENLY DISTRIBUTED / PESO MÁXIMO RECOMENDADO SIENDO ESTE UNIFORMEMENTE DISTRIBUIDO

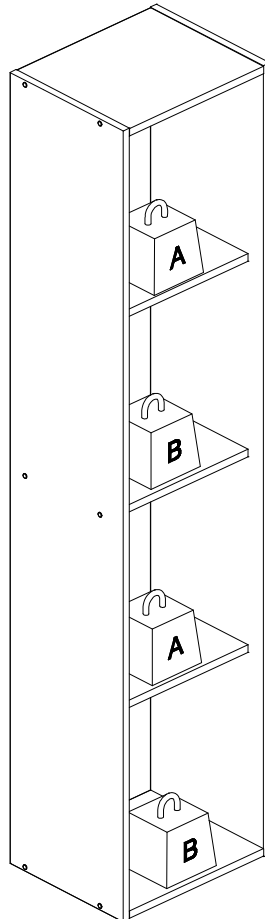

	KG	LB
A	5	11
B	10	22